

ACCESSOIRES  
ACCESSORIES



<b>SERRURE DE COIN RÉVERSIBLE</b> <b>REVERSIBLE CORNER LOCK</b> .....	10.3
<b>CYLINDRE EUROPÉEN</b> <b>EUROPEAN CYLINDER</b> .....	10.3
<b>GÂCHE DE SOL POUR SERRURE</b> <b>FLOOR STRIKER PLATE FOR LOCK</b> .....	10.3
<b>SERRURE CAVALIER</b> <b>SANS ENCOCHE AVEC CYLINDRE</b> <b>CAVALIER LOCK,</b> <b>WITHOUT NOTCH, WITH CYLINDER</b> .....	10.3
<b>LOCQUET POUR PORTE EN VERRE</b> <b>LATCH FOR GLASS DOOR</b> .....	10.4
<b>PROFIL DE SERRAGE DU VERRE</b> <b>POUR PANNEAU FIXE AVEC CACHE</b> <b>GLASS TIGHTENING PROFILE</b> <b>FOR FIXED PANEL WITH COVER</b> .....	10.4
<b>PROFILS U PLIÉ</b> <b>FOLDED U-SECTION</b> .....	10.5
<b>CLÉS DE SERRAGE</b> <b>TIGHTENING WRENCHES</b> .....	10.6
<b>SUPPORTS D'ÉTAGÈRES</b> <b>SHELF SYSTEM</b> .....	10.7

Différents accessoires vous sont proposés de manière à adapter l'installation aux contraintes de votre projet.

Many accessories are available to help you finalize your installation whatever the requirements.

FICHES TECHNIQUES SUR  
[sadev.com](http://sadev.com)  
TECHNICAL INFORMATION ON  
[sadev.com](http://sadev.com)

PHOTO PHOTO	ENCOMBREMENT DIMENSIONS	EPAISSEUR DE VERRE GLASS THICKNESS	RÉFÉRENCE REFERENCE
----------------	----------------------------	---------------------------------------	------------------------

Serrure de coin réversible / Reversible corner lock

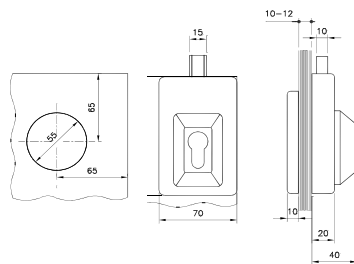

8 mm **09 90 542-215-08**

10 mm **09 90 542-215-10**

12 mm **09 90 542-215-12**

SCHÉMA DRAWING	RÉFÉRENCE REFERENCE
-------------------	------------------------

Cylindre européen ht 59 mm / European cylinder, height 59 mm

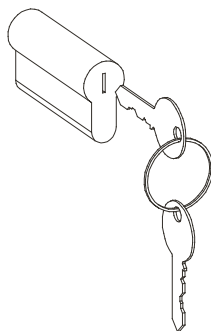

**09 90 V017-30**

Gâche de sol pour serrure V542 / Floor striker plate for lock V542

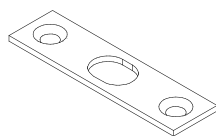

**09 90 542-GA**

PHOTO PHOTO	EPAISSEUR DE VERRE GLASS THICKNESS	RÉFÉRENCE REFERENCE
----------------	---------------------------------------	------------------------

Serrure cavalier sans encoche avec cylindre / Cavalier lock, without notch, with cylinder



10 mm

**09 90 1435-31**

Autres épaisseurs de verre sur commande / Other glass thicknesses on order  
Plus d'informations techniques sur [sadev.com](http://sadev.com) / More information on [sadev.com](http://sadev.com)

**i** FICHES TECHNIQUES SUR [sadev.com](http://sadev.com)  
TECHNICAL INFORMATION ON [sadev.com](http://sadev.com)

PHOTO PHOTO	ENCOMBREMENT DIMENSIONS	EPAISSEUR DE VERRE GLASS THICKNESS	RÉFÉRENCE REFERENCE
----------------	----------------------------	---------------------------------------	------------------------

Locquet pour porte en verre / Latch for glass door

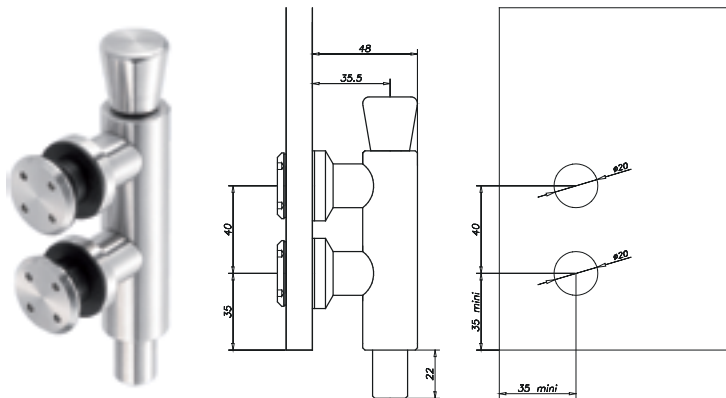

8 → 12 mm

**09 90 03 05**

Profil de serrage du verre pour panneau fixe avec cache  
Glass tightening profile for fixed panel with cover

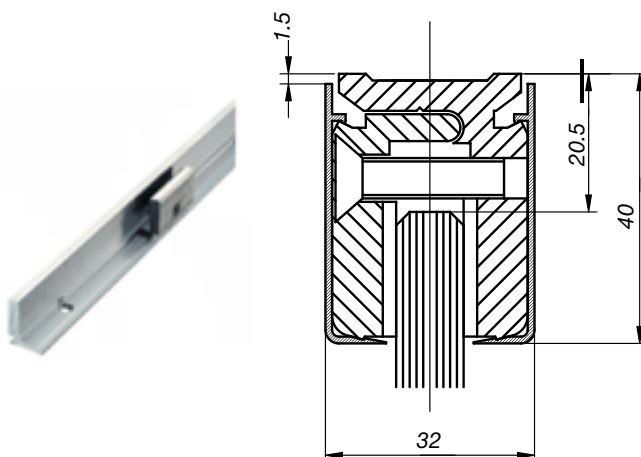

8 mm

**09 94 KL01 R08**

10 mm

**09 94 KL01 R10**

12 mm

**09 94 KL01 R12**

Autres épaisseurs de verre sur commande / Other glass thicknesses on order  
Plus d'informations techniques sur [sadev.com](http://sadev.com) / More information on [sadev.com](http://sadev.com)

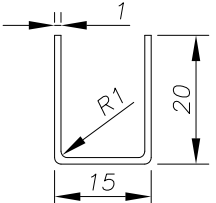
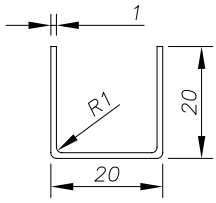
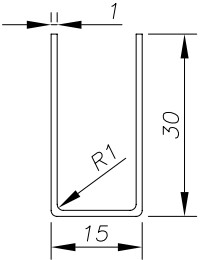
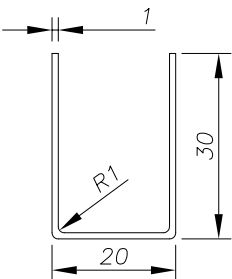
PHOTO PHOTO	ENCOMBREMENT DIMENSIONS	LONGUEUR STANDARD LENGTH	RÉFÉRENCE REFERENCE
	Profil U plié 20×15×1 mm / <i>Folded U-section 20×15×1 mm</i>		
		100 cm	<b>09 90 20 15 1-100</b>
		200 cm	<b>09 90 20 15 1-200</b>
		300 cm	<b>09 90 20 15 1-300</b>
	Profil U plié 20×20×1 mm / <i>Folded U-section 20×20×1 mm</i>		
		100 cm	<b>09 90 20 20 1-100</b>
		200 cm	<b>09 90 20 20 1-200</b>
		300 cm	<b>09 90 20 20 1-300</b>
	Profil U plié 30×15×1 mm / <i>Folded U-section 30×15×1 mm</i>		
		100 cm	<b>09 90 30 15 1-100</b>
		200 cm	<b>09 90 30 15 1-200</b>
		300 cm	<b>09 90 30 15 1-300</b>
	Profil U plié 30×20×1 mm / <i>Folded U-section 30×20×1 mm</i>		
		100 cm	<b>09 90 30 20 1-100</b>
		200 cm	<b>09 90 30 20 1-200</b>
		300 cm	<b>09 90 30 20 1-300</b>

Autres épaisseurs de verre sur commande / *Other glass thicknesses on order*  
Plus d'informations techniques sur [sadev.com](http://sadev.com) / *More information on sadev.com*



FICHES TECHNIQUES SUR  
**sadev.com**  
TECHNICAL INFORMATION ON  
**sadev.com**

PHOTO PHOTO	ENCOMBREMENT DIMENSIONS	RÉFÉRENCE REFERENCE
----------------	----------------------------	------------------------

Clé de serrage compas / *Compass tightening wrench*

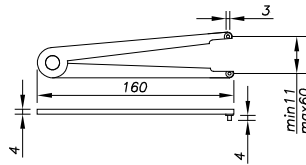

**09 758 11 60**

Clé de serrage cylindrique / *Cylindrical tightening wrench*

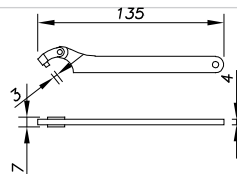

**09 776 C20 35**

PHOTO PHOTO	POIDS WEIGHT	DIAMÈTRE DIAMETER	RÉFÉRENCE REFERENCE
----------------	-----------------	----------------------	------------------------

Forets de perçage spéciaux pour inox / *Special drill bits for stainless steel*



30 g	4,2	<b>09 90 01 42</b>
55 g	6,1	<b>09 90 01 61</b>
75 g	8,2	<b>09 90 01 82</b>

PHOTO PHOTO	POIDS WEIGHT	TARAUDAGE TAPPING	RÉFÉRENCE REFERENCE
----------------	-----------------	----------------------	------------------------

Tarands machine / *Machine taps*



25 g	M4	<b>09 90 02 M4</b>
45 g	M5	<b>09 90 02 M5</b>

PHOTO PHOTO	POIDS WEIGHT	Ø / LONGUEUR Ø / LENGTH	RÉFÉRENCE REFERENCE
----------------	-----------------	----------------------------	------------------------

Goupille élastique inox / *Stainless steel elastic pin*



20 g	4x20	<b>09 90 03 420</b>
42 g	6x35	<b>09 90 03 635</b>
60 g	8x50	<b>09 90 03 850</b>

Autres épaisseurs de verre sur commande / *Other glass thicknesses on order*  
Plus d'informations techniques sur **sadev.com** / *More information on sadev.com*

**SUPPORTS D'ÉTAGÈRES**  
**SHELF SYSTEM**

FICHES TECHNIQUES SUR [sadev.com](http://sadev.com)  
TECHNICAL INFORMATION ON [sadev.com](http://sadev.com)

Les supports d'étagères pour montage sur chandelle vous permettent d'installer des parois vitrées (sanitaire par exemple) de petite dimension. Cette solution permet un nettoyage facile grâce à l'accès sous le vitrage.

*Shelf supports for fitting on pin are used for reduced glass walls dimensions (toilets for example). Easy to clean thanks to the access under the glass.*

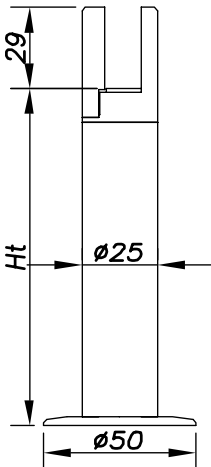
PHOTO PHOTO	ENCOMBREMENT DIMENSIONS	HAUTEUR HEIGHT	EPAISSEUR DE VERRE GLASS THICKNESS	RÉFÉRENCE REFERENCE
Support d'étagère montage sur chandelle / Shelf support for fitting on pin				
		71 mm	6 mm	<b>08 91 81 V6</b>
			8 mm	<b>08 91 81 V8</b>
			10 mm	<b>08 91 81 V10</b>
			12 mm	<b>08 91 81 V12</b>
		91 mm	6 mm	<b>08 91 82 V6</b>
			8 mm	<b>08 91 82 V8</b>
			10 mm	<b>08 91 82 V10</b>
			12 mm	<b>08 91 82 V12</b>
		121 mm	6 mm	<b>08 91 83 V6</b>
			8 mm	<b>08 91 83 V8</b>
			10 mm	<b>08 91 83 V10</b>
			12 mm	<b>08 91 83 V12</b>
		171 mm	6 mm	<b>08 91 84 V6</b>
			8 mm	<b>08 91 84 V8</b>
			10 mm	<b>08 91 84 V10</b>
			12 mm	<b>08 91 84 V12</b>

Autres épaisseurs de verre sur commande / Other glass thicknesses on order  
Plus d'informations techniques sur [sadev.com](http://sadev.com) / More information on [sadev.com](http://sadev.com)



