



# FLUIDO 110

PARTIZIONI E PORTE IN VETRO

Partitions and glass doors - Divisorias y puertas de vidrio  
Glastrennwände und -türen - Divisions et porte en verre

# FLUIDO 110

## SISTEMA SCORREVOLE COMPATTO

COMPACT  
SLIDING  
SYSTEM



Fluido 110 é un sistema per porte scorrevoli in vetro che unisce tecnologia ad un design minimale. Si installa facilmente e rapidamente adattandosi a qualsiasi ambiente residenziale e/o commerciale.

Fluido 110, applicabile ad ante in vetro da 10 a 14mm di spessore e con un peso massimo di 110kg per pannello, nasconde il suo meccanismo all'interno del binario superiore garantendo una linea compatta ed essenziale.

Questo sistema permette inoltre di scegliere tra diversi sistemi di frenaggio: Anti shock, fermo meccanico o la nuova tecnologia **SOFTPRO**, una soluzione unica nel mercato che assicura uno scorrimento leggero, lento e sicuro evitando i forti impatti. Fluido 110 può essere installato a soffitto, parete e falso soffitto. Per le installazioni a parete, la reversibilità del binario permette di avvicinarsi o allontanarsi alla parte a seconda delle necessità.

Il sistema viene offerto in due finiture: alluminio naturale e simil inox satinato.

Fluido 110 is a system for glass sliding doors which combines technology and minimal design. It can be easily and quickly installed, matching every residential and commercial environment.

Fluido 110 fits glass from 10 to 14 mm thick, with a maximum weight of 110 kg per panel. The mechanism is hidden within the upper rail, guaranteeing an essential and compact shape.

Moreover, this system allows to choose among different braking systems: mechanical brake, Antishock and the new technology **SOFTPRO**: this is a unique solution which guarantees a smooth, slow and safe movement, avoiding big hits. Fluido 110 can be fixed to ceiling, wall and false ceiling. As long as wall installation is concerned, the reversibility of the rail allows to set the glass at two distances from the wall, depending on needs.

The system is available in two finishes: natural aluminum and imitation satin stainless steel.

+ info [saheco.com](http://saheco.com)





Proyecto: Rodríguez +Pintos Arquitectos  
Fotografía: Héctor Santos-Díez

# VERSATILE

## PRATICO E SEMPLICE

HANDY AND  
SIMPLE



## MINIMALISTA MINIMALIST



## SICURO E FLUIDO

SECURE  
& FLUID



## COMPATTO COMPACT

FluidO 110 è il sistema compatto ed essenziale in cui tutti gli accessori sono nascosti all'interno della guida, garantendo così un design minimale.

FluidO 110 is the compact and essential system where all accessories are within the rail, giving a minimal design.

## MINIMALE ED ELEGANTE MINIMAL AND ELEGANT

Le contenute dimensioni del sistema permettono di ridurre al minimo la distanza tra vetro e parete, e tra vetro scorrevole e fisso.

The dimensions of the system allow to reduce at its minimum the distance between wall and panel, and between sliding and fixed panel.

## VERSATILE VERSATILE

Un sistema adattabile a qualsiasi tipo di necessità grazie alle diverse opzioni di montaggio a soffitto, a parete e a falso soffitto. Anche con vetro fisso. Disponibile in diverse finiture. Possibilità di **SOFTPRO** o Antishock.

FluidO 110 adapts to every need due to the different possibilities in application: wall, ceiling or false ceiling fixing. It can fit a fixed panel as well. Available in different finishes. Chance of using **SOFTPRO** or Antischok.



**ELEGANTE**  
ELEGANT



**COMPATTO**  
COMPACT



**REVERSIBILE**  
REVERSIBLE

19-17-15mm

30mm

## REVERSIBILE REVERSIBLE

Si può installare a parete su entrambi i lati seguendo i punti guida di foratura. Questa caratteristica, unica nel mondo degli scorrevoli, permette di scegliere la distanza del vetro a parete a seconda delle necessità.

It Can be installed on wall on both sides by following guide fixing holes. This feature, unique in the sliding systems' world, allows to choose the distance between glass and wall according to the different needs.

## SICURO E FLUIDO SECURE AND FLUID

Grazie alla tecnologia **SOFTPRO**, il sistema permette di chiudere e aprire la porta dolcemente evitando contraccolpi negli ultimi centimetri. La sicurezza è garantita.

Thanks to **SOFTPRO** technology, the system allows a smooth movement in opening and closing, avoiding recoils during the last centimetres. Security is guaranteed.

## PRATICO E SEMPLICE HANDY AND SIMPLE

FLUIDO 110 si installa facilmente e rapidamente in qualsiasi ambiente residenziale e/o commerciale. I profili sono dotati di preforature che consentono un rapido posaggio.

Fluido 110 is easily and quickly installed in every commercial and residential environment. The profiles are pre-drilled which allow a rapid installation.

## La nuova tecnologia The new technology

Con il sistema FLUIDO 110 Saheco presenta il nuovo sistema ammortizzante **SOFTPRO**:

Perfettamente compatibile con la compattezza del sistema FLUIDO 110 e di facile e rapido montaggio, il nuovo **SOFTPRO** si può installare con qualsiasi tipo di binario e configurazione.

La novità più importante e unica nel mercato è rappresentata dal suo funzionamento. Il **SOFTPRO** lavora con un sistema combinato idraulico e a gas senza l'impiego di molle, aumentando in questo modo la resistenza, la durabilità e la sicurezza nell'arresto.

Questa caratteristica permette di controllare la velocità di chiusura o di apertura dell'anta negli ultimi 65mm di percorso, garantendo un arresto lento, sicuro e armonico.

La chiusura avviene in decelerazione e in modo costante indipendentemente del peso dell'anta e della forza applicata.

With Fluido 110, Saheco presents its new braking system **SOFTPRO**:

It is perfectly compatible with the dimension of the rail, and it is quick and easy to install: the new **SOFTPRO** fits in every rail and application.

The most important improvement is its operation. **SOFTPRO** works with a combined hydraulic-gas system, without using springs: this increases its resistance, durability and security in braking.

This feature allows to control the closing and opening speed in the last 65 mm, guaranteeing a smooth, safe and harmonic stop.

The weight of the panel and the force applied to it do not influence the closing movement, which is slowed down during the closure.



**INNOVATIVO**  
INNOVATIVE

**UNICO**  
UNIQUE



## Caratteristiche principali Main features

Sistema combinato idraulico e a gas

Fino a 110kg di portata

1020mm minimo di porta per doppio **SOFTPRO**<sup>®</sup>, 725mm minimo con 1 **SOFTPRO**<sup>®</sup> + 1 Antischok

Grado 6 di ciclaggio, 100.000 cicli .

Combined hydraulic-gas system

Up to 110 kg per panel

Minimum width of the door with double **SOFTPRO**<sup>®</sup> 1020mm, with 1 **SOFTPRO**<sup>®</sup> + 1 Antishock 725 mm

100.000 cycles – Grade 6.

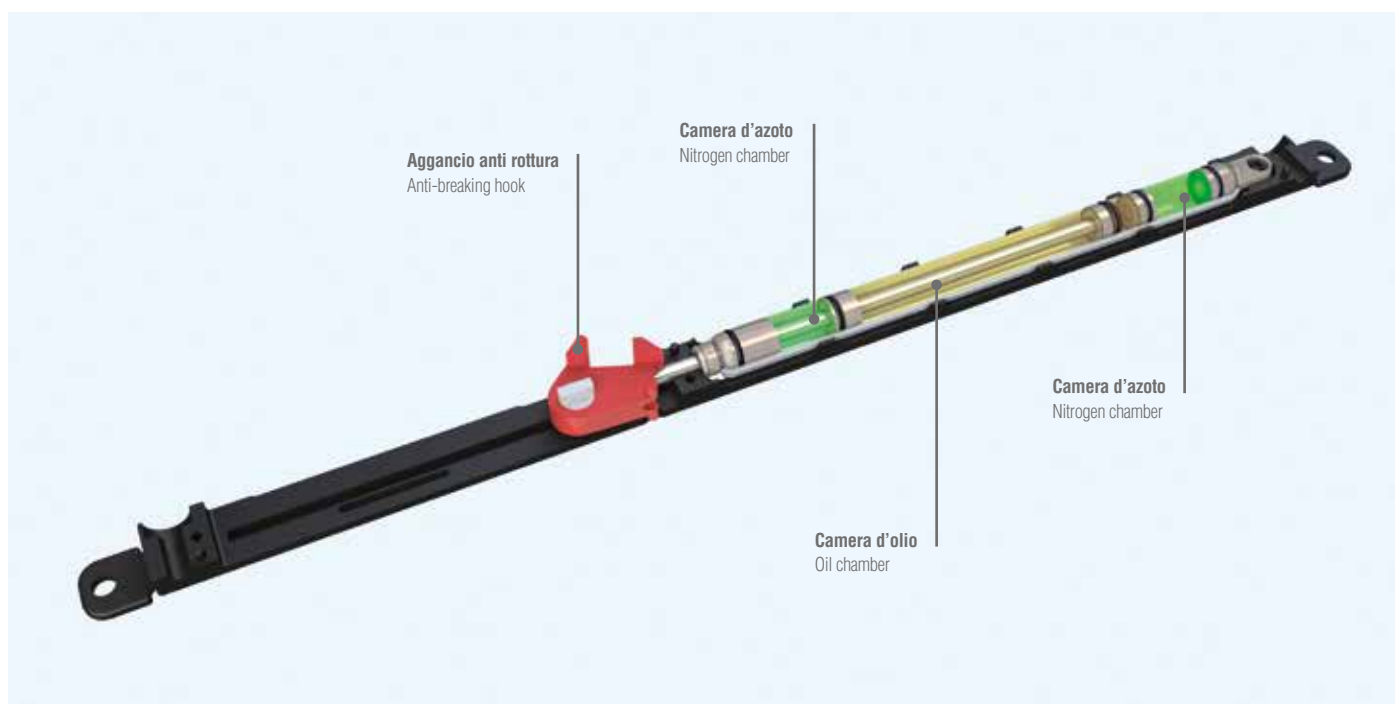



**Per maggiori informazioni vedi video d'installazione:**  
For more informations watch the installation video:

[www.saheco.com](http://www.saheco.com)







# VIDEO NEWS

by Saheco



# CARATTERISTICHE TECNICHE

## TECHNICAL CHARACTERISTICS

### Profili Profiles

**Scorrevole** Sliding  
(fissaggio a parete - wall mounting)

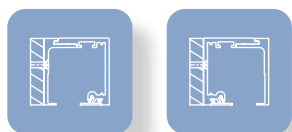

58,5 x 60 mm    58,5 x 60 mm

(fissaggio a soffitto - ceiling mounting)



58,5 x 60 mm

**Scorrevole** Sliding  
(fissaggio a vetro fisso - sidelight mounting)



58,5 x 60 mm    58,5 x 60 mm

**Scorrevole con vetro fisso**  
Sliding with sidelight  
(fissaggio a soffitto - ceiling mounting)



58,5 x 70 mm

**Scorrevole a falso soffitto**  
Sliding false ceiling



76 x 61 mm

**Scorrevole con vetro fisso a falso soffitto**  
Sliding with sidelight on false ceiling



76 x 61 mm

### Dettagli tecnici Technical details

<b>PORTATA</b> Weight	110kg per pannello / for door						
<b>SPESORE VETRO</b> Glass thickness	10 - 12 - 14 mm						
<b>REGOLAZIONE IN ALTEZZA</b> Height adjustment	2 mm						
<b>REVERSIBILITÀ</b> Reversibility	✓						
<b>DISTANZA A PARETE</b> Wall distance	<b>vetro glass 10 mm</b> 19 mm	<b>vetro glass 12 mm</b> 17 mm	<b>vetro glass 14 mm</b> 15 mm				
<b>DISTANZA TRA ANTA E VETRO FISSO</b> Distance between door and sidelight	<b>vetro glass 10 mm</b> 12 mm		<b>vetro glass 12 mm</b> 11 mm				
<b>DISTANZA TRA ANTA E FISSO CON FALSO SOFFITTO</b> Distance between door and sidelight with false ceiling	<b>vetro glass 10 mm</b> 21-19-17 mm		<b>vetro glass 12 mm</b> 19-17-15 mm				
<b>INSTALLAZIONE A VETRO</b> Glass installation	✓						
<b>INSTALLAZIONE A FALSO SOFFITTO</b> False ceiling installation	✓						
<b>SOFTPRO®</b>	Singolo e Doppio / Single and Double						
<b>DIMENSIONI MINIME (doppio SOFTPRO)</b> Minimum dimensions (double SOFTPRO)	1020 mm						
<b>ANTISHOCK</b> Antishock	Singolo e Doppio / Single and Double						
<b>DIMENSIONI MINIME (doppio Antishock)</b> Minimum dimensions (double antishock)	650 mm						
<b>FINITURE</b> Finishes	Alluminio naturale Aluminum	Simil inox Imitation Satin Stainless Steel					
<b>CERTIFICAZIONE DURABILITÀ CICLI CORROSIONE</b> Durability certification Corrosion cycles	<div style="display: flex; align-items: center;"> <div style="writing-mode: vertical-rl; transform: rotate(180deg); font-weight: bold; margin-right: 5px;">IN PROCESSO</div> <table border="1"> <tr> <td>EN1527/EN1670</td> </tr> <tr> <td>6</td> </tr> <tr> <td>100.000</td> </tr> <tr> <td>3 (96h)</td> </tr> </table> </div>			EN1527/EN1670	6	100.000	3 (96h)
EN1527/EN1670							
6							
100.000							
3 (96h)							



## Possibilità di installazione Installation Alternatives

### SCORREVOLE A SOFFITTO Sliding on Ceiling

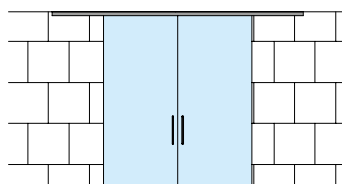
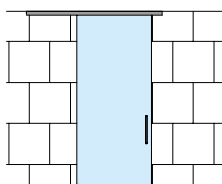
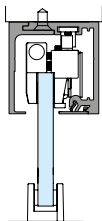

### SCORREVOLE A PARETE Sliding on Wall

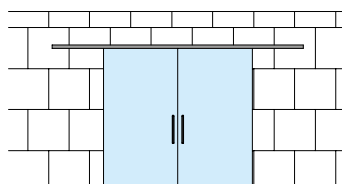
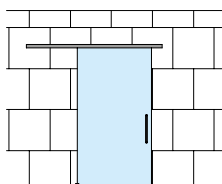
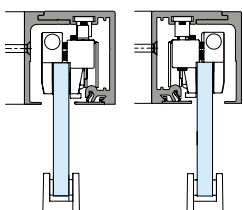

### SCORREVOLE SU VETRO FISSO Sliding on Sidelight

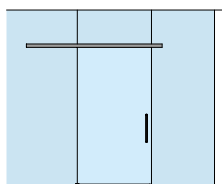
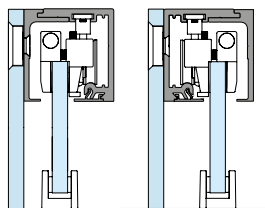

### SCORREVOLE A SOFFITTO CON FISSO Sliding on Ceiling with Sidelight

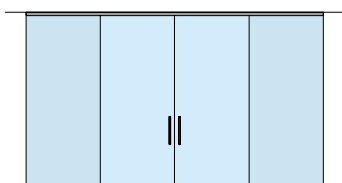
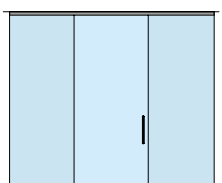
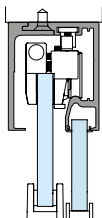

### SCORREVOLE A FALSO SOFFITTO Sliding on False Ceiling

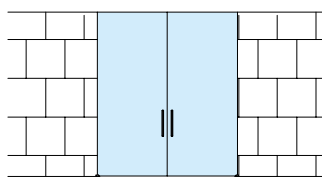
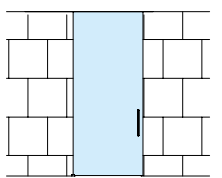
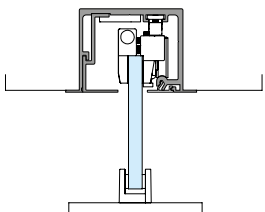

### SCORREVOLE A FALSO SOFFITTO CON FISSO Slider on False Ceiling with Sidelight

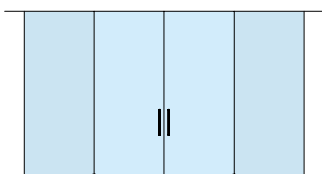
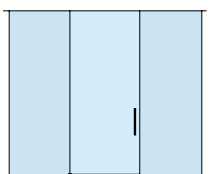
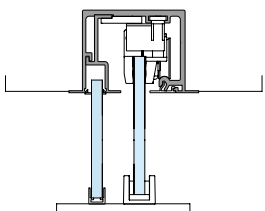

# CONFIGURAZIONI

Configurations

SCORREVOLE A PARETE / SOFFITTO Sliding on Wall / Ceiling

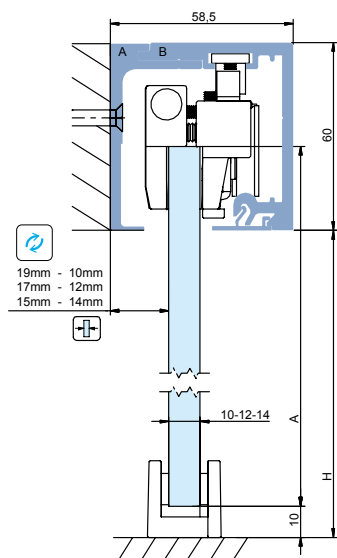

$A = H + 17\text{mm}$

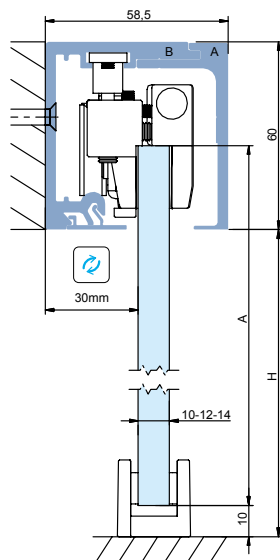

$A = H + 17\text{mm}$

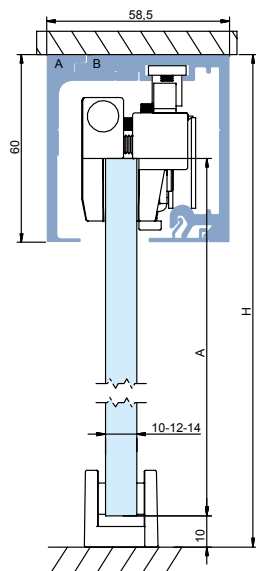

$A = H - 43\text{mm}$

## PORTA SINGOLA Single Door

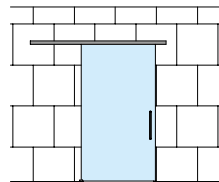
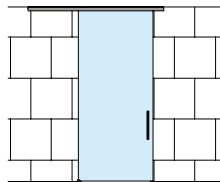

### KIT COMPRENDE:

1 x binario + 1 x kit pinze +  
2 x tappo + 1 x guida a terra  
1 x rail + 1 x kit pliers +  
2 x cap + 1 x floor guide

### 1KB110W K1NN

2 x Freno/Brake standard

### 1KB110W K1AS

1 x SOFTPRO<sup>®</sup> +  
1 x Anti Shock

### 1KB110W K1SS

2 x Doppio/Double  
SOFTPRO<sup>®</sup>

FINITURA 02 alluminio naturale natural aluminum	2 m	2 m	2 m
	3 m	3 m	3 m
	4 m	4 m	4 m
	6 m	6 m	6 m
FINITURA 13 simil inox imitation satin stainless steel	2 m	2 m	2 m
	3 m	3 m	3 m
	4 m	4 m	4 m
	6 m	6 m	6 m

## PORTA DOPPIA Double Door

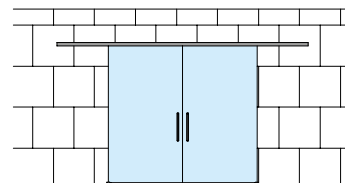
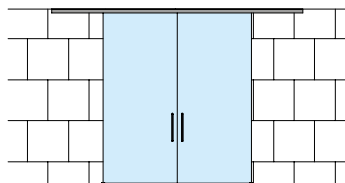

### KIT COMPRENDE:

1 x binario + 2 x kit pinze +  
1 x tappo + 2 x guida a terra  
1 x rail + 2 x kit pliers +  
1 x cap + 2 x floor guide

### 2KB110W K1NN

2 x Freno/Brake standard

### 2KB110W K1AS

1 x SOFTPRO<sup>®</sup> +  
1 x Anti Shock

### 2KB110W K1SS

2 x Doppio/Double  
SOFTPRO<sup>®</sup>

FINITURA 02 alluminio naturale natural aluminum	2 m	2 m	2 m
	3 m	3 m	3 m
	4 m	4 m	4 m
	6 m	6 m	6 m
FINITURA 13 simil inox imitation satin stainless steel	2 m	2 m	2 m
	3 m	3 m	3 m
	4 m	4 m	4 m
	6 m	6 m	6 m

# SCORREVOLE A SOFFITTO CON FISSO Sliding on Ceiling with Sidelight



## PORTA SINGOLA Single Door

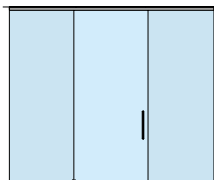

**KIT COMPRENDE:**  
**1 x binario + 1 x kit pinze**  
**+ 1 x guida a terra**  
 1 x rail + 1 x kit pliers  
 + 1 x floor guide

**3KB110W K1NN**  
 2 x Freno/Brake standard

**3KB110W K1AS**  
 1 x SÖFTPRO® +  
 1 x Anti Shock

**3KB110W K1SS**  
 2 x Doppio/Double  
 SÖFTPRO®

FINITURA 02 alluminio naturale natural aluminum	2 m	2 m	2 m
	3 m	3 m	3 m
	4 m	4 m	4 m
	6 m	6 m	6 m
FINITURA 13 simil inox imitation satin stainless steel	2 m	2 m	2 m
	3 m	3 m	3 m
	4 m	4 m	4 m
	6 m	6 m	6 m

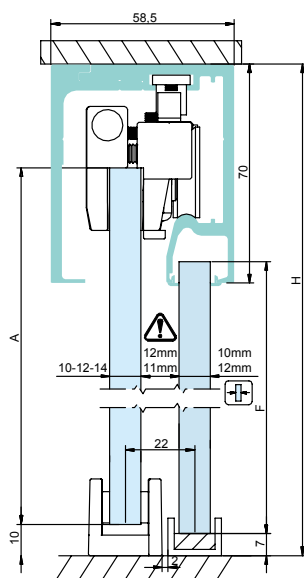

$$A=H - 43\text{mm}$$

$$F=H - 70\text{mm}$$

## PORTA DOPPIA Double Door

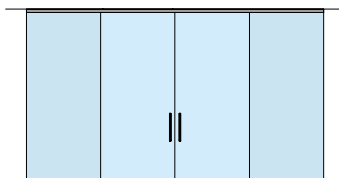

**KIT COMPRENDE:**  
**1 x binario + 2 x kit pinze**  
**+ 2 x guida a terra**  
 1 x rail + 2 x kit pliers  
 + 2 x floor guide

**4KB110W K1NN**  
 2 x Freno/Brake standard

**4KB110W K1AS**  
 1 x SÖFTPRO® +  
 1 x Anti Shock

**4KB110W K1SS**  
 2 x Doppio/Double  
 SÖFTPRO®

FINITURA 02 alluminio naturale natural aluminum	2 m	2 m	2 m
	3 m	3 m	3 m
	4 m	4 m	4 m
	6 m	6 m	6 m
FINITURA 13 simil inox imitation satin stainless steel	2 m	2 m	2 m
	3 m	3 m	3 m
	4 m	4 m	4 m
	6 m	6 m	6 m

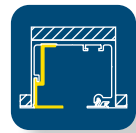

## SCORREVOLE A FALSO SOFFITTO Sliding on False Ceiling

### PORTA SINGOLA Single Door

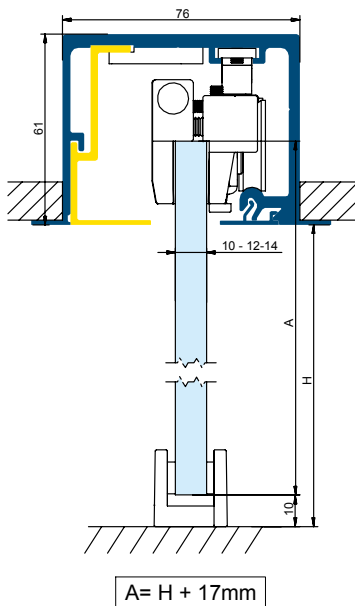
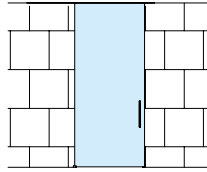

**KIT COMPRENDE:**  
**1 x binario + 1 x kit pinze**  
**+ 1 x guida a terra**  
 1 x rail + 1 x kit pliers  
 + 1 x floor guide

**5KB110W K1NN**  
 2 x Freno/Brake standard

**5KB110W K1AS**  
 1 x SÖFTPRO® +  
 1 x Anti Shock

**5KB110W K1SS**  
 2 x Doppio/Double  
 SÖFTPRO®

FINITURA 02 alluminio naturale natural aluminum	2 m	2 m	2 m
	3 m	3 m	3 m
	4 m	4 m	4 m
	6 m	6 m	6 m
FINITURA 13 simil inox imitation satin stainless steel	2 m	2 m	2 m
	3 m	3 m	3 m
	4 m	4 m	4 m
	6 m	6 m	6 m

### PORTA DOPPIA Double Door

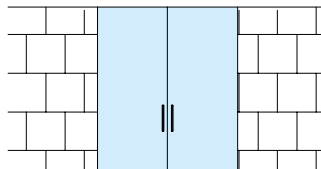

**KIT COMPRENDE:**  
**1 x binario + 2 x kit pinze**  
**+ 2 x guida a terra**  
 1 x rail + 2 x kit pliers  
 + 2 x floor guide

**6KB110W K1NN**  
 2 x Freno/Brake standard

**6KB110W K1AS**  
 1 x SÖFTPRO® +  
 1 x Anti Shock

**6KB110W K1SS**  
 2 x Doppio/Double  
 SÖFTPRO®

FINITURA 02 alluminio naturale natural aluminum	2 m	2 m	2 m
	3 m	3 m	3 m
	4 m	4 m	4 m
	6 m	6 m	6 m
FINITURA 13 simil inox imitation satin stainless steel	2 m	2 m	2 m
	3 m	3 m	3 m
	4 m	4 m	4 m
	6 m	6 m	6 m

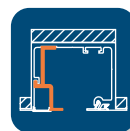

# SCORREVOLE A FALSO SOFFITTO CON FISSO Sliding on False Ceiling with Sidelight

## PORTA SINGOLA Single Door

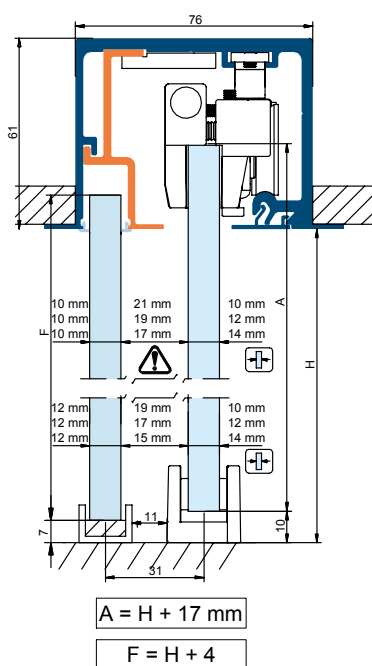
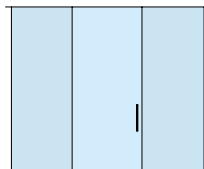

### KIT COMPRENDE:

**1 x binario + 1 x kit pinze**  
**+ 1 x guida a terra**  
 1 x rail + 1 x kit pliers  
 + 1 x floor guide

### 7KB110W K1NN

2 x Freno/Brake standard

### 7KB110W K1AS

1 x SOFTPRO<sup>®</sup> +  
 1 x Anti Shock

### 7KB110W K1SS

2 x Doppio/Double  
 SOFTPRO<sup>®</sup>

FINITURA 02 alluminio naturale natural aluminum	2 m	2 m	2 m
	3 m	3 m	3 m
	4 m	4 m	4 m
	6 m	6 m	6 m
FINITURA 13 simil inox imitation satin stainless steel	2 m	2 m	2 m
	3 m	3 m	3 m
	4 m	4 m	4 m
	6 m	6 m	6 m

## PORTA DOPPIA Double Door

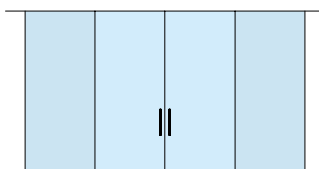

### KIT COMPRENDE:

**1 x binario + 2 x kit pinze**  
**+ 2 x guida a terra**  
 1 x rail + 2 x kit pliers  
 + 2 x floor guide

### 8KB110W K1NN

2 x Freno/Brake standard

### 8KB110W K1AS

1 x SOFTPRO<sup>®</sup> +  
 1 x Anti Shock

### 8KB110W K1SS

2 x Doppio/Double  
 SOFTPRO<sup>®</sup>

FINITURA 02 alluminio naturale natural aluminum	2 m	2 m	2 m
	3 m	3 m	3 m
	4 m	4 m	4 m
	6 m	6 m	6 m
FINITURA 13 simil inox imitation satin stainless steel	2 m	2 m	2 m
	3 m	3 m	3 m
	4 m	4 m	4 m
	6 m	6 m	6 m

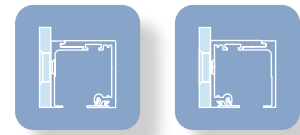

## SCORREVOLE SU VETRO FISSO Sliding on Sidelight

### PORTA SINGOLA Single Door

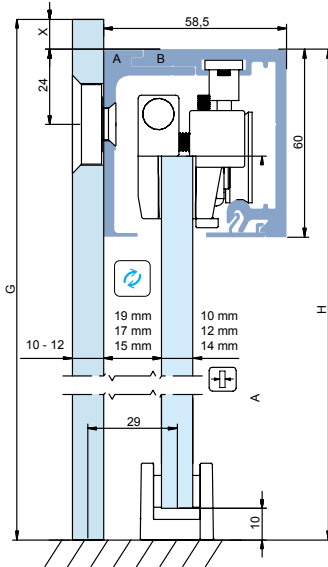

$$A = H - 43 \text{ mm}$$

$$G = H + X$$

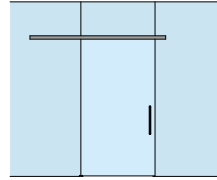

**KIT COMPRENDE:**  
**1 x binario + 1 x kit pinze**  
**2 x tappo + 1 x guida a terra**  
 1 x rail + 1 x kit pliers  
 2 x cap + 1 x floor guide

**9KB110W K1NN**  
 2 x Freno/Brake standard

**9KB110W K1AS**  
 1 x SOFTPRO<sup>®</sup> +  
 1 x Anti Shock

**9KB110W K1SS**  
 2 x Doppio/Double  
 SOFTPRO<sup>®</sup>

FINITURA 02 alluminio naturale natural aluminum	2 m	2 m	2 m
	3 m	3 m	3 m
	4 m	4 m	4 m
	6 m	6 m	6 m
FINITURA 13 simil inox imitation satin stainless steel	2 m	2 m	2 m
	3 m	3 m	3 m
	4 m	4 m	4 m
	6 m	6 m	6 m

NOTA: Aggiungere al prezzo del kit il prezzo delle borchie cod.B70WP7031  
 2mt = 10 borchie / 2,5mt = 12 borchie / 3mt = 15 borchie / 5mt = 25 borchie

### PORTA DOPPIA Double Door

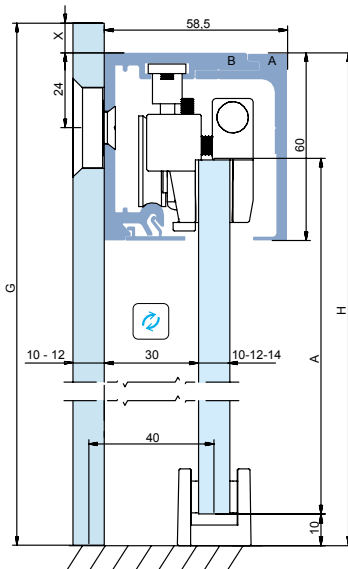

$$A = H - 43 \text{ mm}$$

$$G = H + X$$

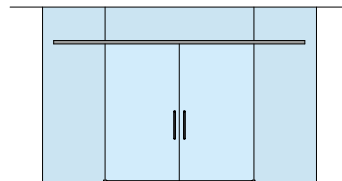

**KIT COMPRENDE:**  
**1 x binario + 2 x kit pinze**  
**2 x tappo + 2 x guida a terra**  
 1 x rail + 2 x kit pliers  
 2 x cap + 2 x floor guide

**10KB110W K1NN**  
 2 x Freno/Brake standard

**10KB110W K1AS**  
 1 x SOFTPRO<sup>®</sup> +  
 1 x Anti Shock

**10KB110W K1SS**  
 2 x Doppio/Double  
 SOFTPRO<sup>®</sup>

FINITURA 02 alluminio naturale natural aluminum	2 m	2 m	2 m
	3 m	3 m	3 m
	4 m	4 m	4 m
	6 m	6 m	6 m
FINITURA 13 simil inox imitation satin stainless steel	2 m	2 m	2 m
	3 m	3 m	3 m
	4 m	4 m	4 m
	6 m	6 m	6 m

NOTA: Aggiungere al prezzo del kit il prezzo delle borchie cod.B70WP7031  
 2mt = 10 borchie / 2,5mt = 12 borchie / 3mt = 15 borchie / 5mt = 25 borchie

# COMPOSIZIONE KITS Kits Composition

## SETS PROFILI

Sets Profiles

Cod.



Set profili per installazione a parete / a soffitto



Set profiles installed on wall / ceiling

B110W K41/2	2 m
B110W K41/3	3 m
B110W K41/4	4 m
B110W K41/6	6 m

**Finitura**  
Finishes **02**
**Finitura**  
Finishes **13**

## SETS PROFILI CON VETRO FISSO

Sets Profiles with Sidelight

Cod.



Set profili per installazione con vetro fisso



Set profiles installed on sidelight

B110W K43/2	2 m
B110W K43/3	3 m
B110W K43/4	4 m
B110W K43/6	6 m

**Finitura**  
Finishes **02**
**Finitura**  
Finishes **13**

## SETS PROFILI FALSO SOFFITTO

Sets Profiles False Ceiling

Cod.



Set profili per installazione falso soffitto

Set profiles installed on false ceiling

B110W K44/2	2 m
B110W K44/3	3 m
B110W K44/4	4 m
B110W K44/6	6 m

**Finitura**  
Finishes **02**
**Finitura**  
Finishes **13**

## SETS PROFILI FALSO SOFFITTO CON VETRO FISSO

Sets Profiles False Ceiling with Sidelight

Cod.



Set profili per installazione falso soffitto con vetro fisso

Set profiles installed on false ceiling with sidelight

B110W K45/2	2 m
B110W K45/3	3 m
B110W K45/4	4 m
B110W K45/6	6 m

**Finitura**  
Finishes **02**
**Finitura**  
Finishes **13**

## SET ACCESSORI

Set of Accessories

Cod.

 Set tappi laterali per profili a soffitto o a parete in plastica  
Set of side caps for ceiling profiles or plastic walls

B110W P61

**Finitura**  
Finishes **02**
**Finitura**  
Finishes **13**

 Set tappi laterali per profili con vetro fisso in plastica  
Set of side caps for profiles with plastic sidelight

B110W P63

**Finitura**  
Finishes **02**
**Finitura**  
Finishes **13**

## ACCESSORI

Accessories

Cod.

 Guida inferiore per vetro 8-10mm  
Bottom U-channel for 8-10 mm

B110W P50

**Finitura**  
Finishes **02**
**Finitura**  
Finishes **13**

Alluminio naturale

**02**













Simil Inox satinato

**13**

## SET ACCESSORI

Set of Accessories

Cod.

		<p>Set di accessori <b>SOFTPRO</b> doppio Set of accessories for double <b>SOFTPRO</b></p>	<p>B110W K1SS</p>	<p><b>Finitura</b> Finishes <b>00</b></p>
		<p>Set di accessori <b>SOFTPRO</b> + Anti Shock Set of accessories for <b>SOFTPRO</b> + anti shock</p>	<p>B110W K1AS</p>	<p><b>Finitura</b> Finishes <b>00</b></p>
		<p>Set di accessori 2 Anti Shock Set of accessories for 2 anti shocks</p>	<p>B110W K1AA</p>	<p><b>Finitura</b> Finishes <b>00</b></p>
		<p>Set di accessori Fermo meccanico + Anti Shock Set of accessories for stop + anti shock</p>	<p>B110W K1NA</p>	<p><b>Finitura</b> Finishes <b>00</b></p>
		<p>Set di accessori <b>SOFTPRO</b> + Fermo meccanico Set of accessories for <b>SOFTPRO</b> + stop</p>	<p>B110W K1NS</p>	<p><b>Finitura</b> Finishes <b>00</b></p>
		<p>Set di accessori 2 Fermi meccanici Set of accessories for 2 stops</p>	<p>B110W K1NN</p>	<p><b>Finitura</b> Finishes <b>00</b></p>

## ACCESSORI

Accessories

Cod.



Supporto per fissaggio a parete  
a vetro fisso  
Support for wall mounting  
with sidelight

B70W P7031

**Finitura**  
Finishes **31**

Alluminio naturale

02

Simil Inox satinato

13







## NOTE

---

---

---

---

---

---

---

---

---

---

---

---

---

---

---

---

---

---

---

---

---

---

---

---

---

---

---

---

ES

## Fluido 110 DIVISORIAS Y PUERTAS DE VIDRIO SISTEMA CORREDERAS COMPACTO

Fluido 110 es un sistema para puertas de vidrio correderas que une tecnología y diseño minimalista. Se instala fácil y rápidamente adaptándose a cualquier ambiente residencial o comercial.

Fluido 110, aplicable para puertas de vidrio de 10-14 mm de espesor y peso máximo de 110kg por puerta, esconde su mecanismo en el interior de la guía superior garantizando una línea compacta y elegante.

Este sistema de puertas correderas permite escoger opcionalmente el frenado mecánico, anti-shock o SoftPRO asegurando de esta manera un recorrido suave y seguro evitando impactos con fuerza. Para la instalación a pared, al ser la guía reversible, se puede reducir a la mínima distancia de separación entre pared y vidrio, según cada necesidad. Fluido 70 se puede instalar a techo, a pared y a falso techo. El sistema se suministra en dos acabados: aluminio natural y simil inox satinado.

### COMPACTO

Fluido 110 es el sistema compacto y elegante en el cual todos los accesorios se esconden en el interior de la guía garantizando un diseño minimalista.

### MINIMALISTA Y ELEGANTE

Las dimensiones reducidas del sistema permiten reducir al mínimo la distancia entre vidrio y pared, así como entre puerta y vidrio fijo en su caso.

### VERSÁTIL

Un sistema adaptable a cualquier tipo de necesidad gracias a las diversas opciones de montaje, a techo, a pared y a falso techo. También con vidrio fijo. Disponible en diversos acabados. SoftPRO o Antishock opcionales.

### REVERSIBLE

Se puede instalar entre paredes siguiendo los puntos de mecanizado. Esta característica, única en el mundo de las correderas, permite escoger la distancia del vidrio a la pared según necesidad.

### SEGURIDAD Y FLUIDEZ

Gracias a la tecnología SoftPRO, el sistema permite cerrar y abrir la puerta suavemente evitando los impactos de los centímetros finales. La seguridad está garantizada.

### PRÁTICO Y SIMPLE

FLUIDO 110 se instala fácil y rápidamente en cualquier ambiente residencial y/o comercial. Los perfiles ya vienen taladrados lo cual permite una rápida instalación.

### SOFT-PRO®

#### La nueva tecnología Soft-PRO

Con el sistema FLUIDO 110 COLCOM presenta un nuevo sistema de amortiguación. Perfectamente compatible y de fácil y rápido montaje, el nuevo Soft-PRO se puede instalar con cualquier tipo de guía y configuración.

La novedad más importante y única del mercado está representada con su funcionamiento. El Soft-PRO trabaja con un sistema combinado hidráulico y a gas sin incluir muelles, aumentando de esta manera la resistencia, la durabilidad y la seguridad en el cierre.

Esta característica permite controlar la velocidad de cierre o apertura de la hoja en los últimos 65mm de su recorrido, garantizando un frenado suave, seguro y armónico.

El frenado permite desacelerar de manera constante independientemente del peso de la hoja y de la fuerza aplicada.

FR

## Fluido 110 LES DIVISIONS ET PORTE EN VERRE LE SYSTÈME COULISSANTE COMPACTE

Fluido 110 c'est un système pour porte coulissante en verre qui combine technologie et un dessin minimaliste. Avec une installation facile et rapide il permet s'adapter tous les ambients résidentiels et commerciales.

Le FLUIDO 110 est disponible pour portes en verre d'épaisseur de 10-14mm et avec un poids maximum de 110 kg par panneau, son mécanisme est occulté dans le rail supérieur assurant une ligne compacte et essentielle.

Ce système permet en plus de choisir le type de freinage : antiShock, Freinage Mécanique au la nouvelle technologie SoftPRO, une solution unique sur le marché que assure un coulisage légère et Secure évitant des forts coups. Le FLUIDO peut avoir une installation sur plafond, mur et faux plafond en fonction de la nécessité de l'installation. Le système est proposé en deux finitions: Aluminium Naturel et Aluminium Anodisé Argent.

### COMPACTE

Fluido 110 c'est un système compacte es essentiel dans laquelle tous les accessoires sont placés à l'intérieur du rail en donnant un dessin minimaliste.

### MINIMALISTE ET ÉLEGANTE

La forme du système permet réduire au minimum la distance entre le verre et le mur en installation de verre fixe au coulissant.

### VERSATILE

Système adaptable à tous les types d'installation grâce à ses options de montage plafond, murale, faux-plafond, inclus avec verre fixe. Disponible en différentes finitions. Possibilité de SoftPRO et AntiShock.

### REVERSIBLE

Il peut être installé sur les deux côtés suivant la marque en pointillés. Cette caractéristique, le seul dans le monde des systèmes coulissants, permet choisir la distance entre le verre et le mur selon les nécessités.

### SECURE ET FLUIDE

Grâce à la technologie SoftPRO, le système permet ouvrir et fermer la porte doucement et éviter le coup aux dernières centimètres. Sécurité et garantie.

### PRATIQUE ET SIMPLE

Fluido 70 permet une installation rapide dans des ambients résidentiels et commerciaux. Les rails Pre-mécanisés permettent une installation rapide.

### SOFT-PRO®

#### La nouvelle technologie Soft-PRO

Avec le FLUIDO110, Saheco présente le nouveau système amortisseur

Le système est parfaitement compatible avec le dessin compact du système et son système d'installation rapide. Le nouveau SoftPRO peut s'installer presque avec toutes les configurations disponibles.

La nouveauté plus remarquable c'est le fonctionnement. Le fonctionne avec une combinaison du système hydraulique et un piston à gaz qui fait augmenter la résistance, la durabilité et la sécurité du produit.

Cette caractéristique permet de contrôler la vitesse à l'ouverture et fermeture de la porte aux dernières 65mm du trajet et garantir une fermeture doux et sécurisée.

La fermeture est, réalisée progressivement du manière constante Independentment du force appliqué sur la porte.

DE

## Fluido 110 GLASTRENNWÄNDE UND -TÜREN KOMPAKTES SCHIEBETÜRSYSTEM

Fluido 110 ist ein Schiebetürsystem für Glastüren, das Technologie mit einem minimalistischem Design verbindet. Das System kann schnell und einfach montiert werden, und eignet sich sowohl für gewerbliche als auch private Räumlichkeiten.

Fluido 110, ist für vorgespanntes Glas mit einer Glasdicke von 10 bis 14mm geeignet und einem maximalen Gewicht von 110 kg pro Scheibe. Der Mechanismus ist durch die Schiene verdeckt und gibt dem System daher eine elegante Form.

Das Schiebetürsystem bietet alternativ, neben der Standardbremse, eine integrierte Anti-Shock Brems oder eine Softclose-Bremse an, durch die eine behutsame und kontrollierte Schließung der Tür ermöglicht wird. Fluido 110 kann an der Decke, der Wand oder einer abgehängten Decke montiert werden. Für die Wandmontage bietet die Reversibilität des binären Systems die Möglichkeit, je nach Anforderung, näher oder weiter weg von der Wand zu montieren. Das System ist in zwei Oberflächen erhältlich: EV 1 oder Niro ähnlich.

### KOMPAKT

Fluido 110 ist ein kompaktes und elegantes System, bei dem sich der gesamte Mechanismus hinter der Abdeckung der Schiene verbirgt und somit ein minimalistisches Design aufweist.

### MINIMAL UND ELEGANT

Die Maße des Systems erlauben einen reduzierten Abstand zwischen Wand und Glasscheibe und zwischen dem Schiebement und dem festen Element.

### VIELSEITIG

Das System passt sich durch seine Vielfältigkeit den Montageansprüchen, ob an Wand, Decke oder abgehängter Decke, an. Es kann auch an einem festen Glasteilelement montiert werden. Erhältlich in verschiedenen Oberflächen. Ausführung mit Soft-PRO Bremse oder Antishock-Bremse möglich.

### REVERSIBEL

Es kann an der Wand von beiden Seiten montiert werden, indem man die vorgebohrten Befestigungslöcher verwendet. Dieses Merkmal, das im Bereich der Schiebetürsysteme einzigartig ist, erlaubt es, den Abstand zwischen Glas und Wand, je nach Einbausituation zu wählen.

### SICHER UND FLIESSEND

Dank der Soft-PRO-Technologie, ermöglicht das System eine sanfte Öffnung wie auch Schließung, ohne Rückstöße. Garantierte Sicherheit.

### HANDLICH UND EINFACH

Fluido 110 ist leicht und schnell zu montiert, egal ob in gewerblichen oder privaten Bereichen. Das Profil ist vorgebohrt und ermöglicht somit eine schnelle Montage.

### SOFT-PRO®

#### Die neue Soft-PRO Technologie

Mit dem System FLUIDO 110 präsentiert Saheco einen neuartigen Dämpfungsmechanismus. Das neue Soft-PRO ist perfekt kompatibel mit FLUIDO 110 und zudem schnell und einfach zu montieren. Es kann ebenfalls mit fast jeder Schiebetürschiene kombiniert und konfiguriert werden.

Die wichtigste Neuigkeit jedoch, und einmalig auf dem Markt, ist die der integrierte Mechanismus. Soft-PRO basiert auf einer Kombination eines hydraulischen- und eines auf Gas basierenden Systems, ohne Verwendung von Federn. Hierdurch werden der Widerstand, die Lebensdauer und die Sicherheit während des Schließprozesses erhöht.

Der Mechanismus erlaubt die Kontrolle der Schließ- sowie der Öffnungsgeschwindigkeit des Schiebeflügels und garantiert somit eine kontrollierte, sicher und harmonische Schließung der Schiebetür. Die konstante langsame Schließgeschwindigkeit ist unabhängig vom dem Gewicht der Glasscheibe und der dadurch entstehenden Kräfte.



COLCOM GROUP SPA  
Via Degli Artigiani 56  
25075 Nave (Brescia) Italia  
Tel. 030 2532008  
Fax 030 2534707  
info@colcomgroup.it

+ info [saheco.com](http://saheco.com)



**saheco**  
sistemi per porte scorrevoli